



Polycold Fast Cycle (PFC) Water Vapor Cryopump Operation Manual



FOR SALES AND SERVICE PLEASE CALL:

PTB SALES T :: 626.334.0500
service@ptbsales.com
www.ptbsales.com

DATE SERVICED: _____

VIEW OUR INVENTORY

Information provided within this document is subject to change without notice, and although believed to be accurate, Brooks Automation assumes no responsibility for any errors, omissions, or inaccuracies.

AcuLigner, AcuLine, AcuTran, AcuTrav, AeroLoader IV, AeroTrak, ARV 2000, AquaTran, Atmospheric Express, BALI 400 Indexer, BiSymmetrik, ExpressLock, FabExpress, FixLoad, FrogLeg, Gemini, Gemini Express, Gemini Express Tandem, Guardian Bare Reticle Stocker, Hercules, Hercules Express, InCooler, InLigner, InLine Express, Leapfrog, Linear eXchange, MagnaTran 7, MagnaTran 70, MagnaTran 8, MagnaTran X, Marathon, Marathon Express, Marathon Express Tandem, MicroTool, MultiTran, OneFab AMHS, OpenMTS, PASIV, PF-100, PowerPak, Reliance ATR, Reliance DFR, Reliance WCR, SENTRY, TCM, Time Optimal Trajectory, TopCooler, TurboStocker, TurboStocker XT, Ultrasort, VacuTran, VCD, VCE, VPE, WAVE, WAVE II, Zaris, and Z-Bot are trademarks of Brooks Automation Hardware. All other trademarks are properties of their respective owners.

© Brooks Automation 2011, All Rights Reserved. The information included in this manual is Brooks Proprietary Information and is provided for the use of Brooks customers only and cannot be used for distribution, reproduction, or sale without the expressed written permission of Brooks Automation. This information may be incorporated into the user's documentation, however any changes made by the user to this information is the responsibility of the user.



Brooks Automation

15 Elizabeth Drive

Chelmsford, MA 01824

Phone +1 (978) 262-2400

Fax +1 (978) 262-2500

For emergencies, contact Technical Support 1-800-FOR-GUTS (800-367-4887)

www.brooks.com

This manual is available in the following formats: CD, Paper

This manual is available in the following languages: English.

This technology is subject to United States export Administration Regulations and authorized to the destination only; diversion contrary to U.S. law is prohibited.

Printed in the U.S

Contents

1. Introduction	3
Description and Applications	3
PFC Versions.....	6
PFC Performance Specifications.....	7
Using this Manual	9
2. Safety	10
Overview	10
Safety Alerts Defined	11
Safety Precautions for the PFC	13
Safety Guidelines	16
Equipment Guidelines.....	17
Standard Symbols on the Equipment	19
Safety Labels on the PFC	20
Safety and Operational Interlocks.....	36
General Hazards	37
Electrical Hazards	40
Lockout/Tagout (LOTO).....	43
Gas Hazards.....	45
Vacuum Hazards	46
Fire and Explosion Hazards	47
Recycling.....	48
Chemical Hazards	48
Emergency Conditions	49
Emergency Contact Information	49
Material Safety Data Sheets	50
3. Operation	51
Controls and Indicators	51
Modes of Operation.....	54
Operating the PFC with a Cryocoil.....	56
Operating the PFC with a Cryobaffle.....	59
4. Appendix	61
Cryosurface Temperature Versus Water Vapor Partial Pressure	61

This Page left Intentionally Blank

1. Introduction

Description and Applications

**WARNING**

Do not attempt to perform any installation, operation, or maintenance procedures on the PFC until you have thoroughly read and understood the information in the Safety section of this Manual. Failure to heed this warning can result in serious injury or death.

Primary Definitions:

- **Refrigeration Unit:** The enclosure that cools and pumps the refrigerant through the *refrigerant line* and cryosurface.
- **Refrigerant Line:** In this manual, this term refers to the insulated bundle that contains two lines (supply and return) that conducts a refrigerant between the PFC refrigeration unit and the cryosurface.
- **Cryosurface:** This is the cooling surface that is installed in the customer's vacuum chamber. It is usually shaped either as a coil (for water vapor capture), or as a ring of baffles (for capturing backstreaming oil).

In this manual, the Polycold Fast Cycle (PFC) water vapor cryopump is referred to as the “PFC.”

The PFC is a cryogenic refrigeration system that captures volatile molecules by freezing them onto a cold surface. The PFC consists of a refrigeration unit, refrigerant lines (supply and return), and a cryosurface with cryogenic feedthrough. The refrigeration unit can pump cold or hot refrigerant (for defrost) in a continuous loop through the refrigerant lines and cryosurface. The refrigerant is a proprietary mixture of refrigerants made by Brooks Polycold Systems Inc.

Within the refrigeration unit, heat absorbed by the refrigerant is transferred to water that is supplied by the customer.

Primary application: Capture water vapor in a vacuum chamber after opening the high vacuum valve. Water vapor is usually the most reactive contaminant in a high-vacuum system, and comprises 65% to 95% of the residual gas in such systems.

For this application, the cryosurface is normally a coil. The coil can be quickly cooled and defrosted to correspond with vacuum chamber cycles. See Figure 1.

Secondary application: The PFC can also be used to minimize backstreaming (see Figure 2). Backstreaming is a phenomenon where oil diffusion pumps are used. Some of the hot oil from the diffusion pump migrates into the vacuum chamber, where it condenses onto surfaces, contaminating the system. For this application, the cryosurface is a baffle. “Fast Cycle” refers to the fast interchange between the cold and defrost states. However, quick cooling and defrosting is not normally required or desired for this application.

Continued on next page

Description and Applications, Continued

Figure 1. PFC Used to Capture Water Vapor

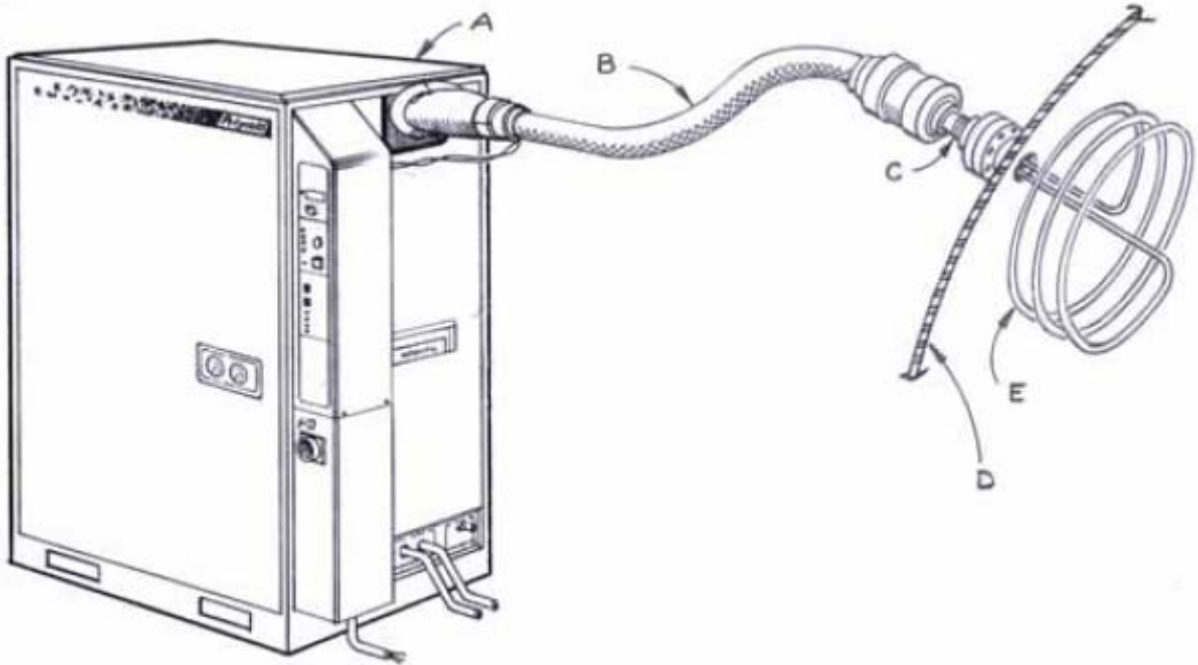

Legend:

- A. Refrigeration Unit
- B. Refrigerant line
- C. Cryogenic feedthrough
- D. Vacuum chamber wall
- E. Cryosurface

Continued on next page

Description and Applications, Continued

Figure 2. PFC Used to Minimize Backstreaming

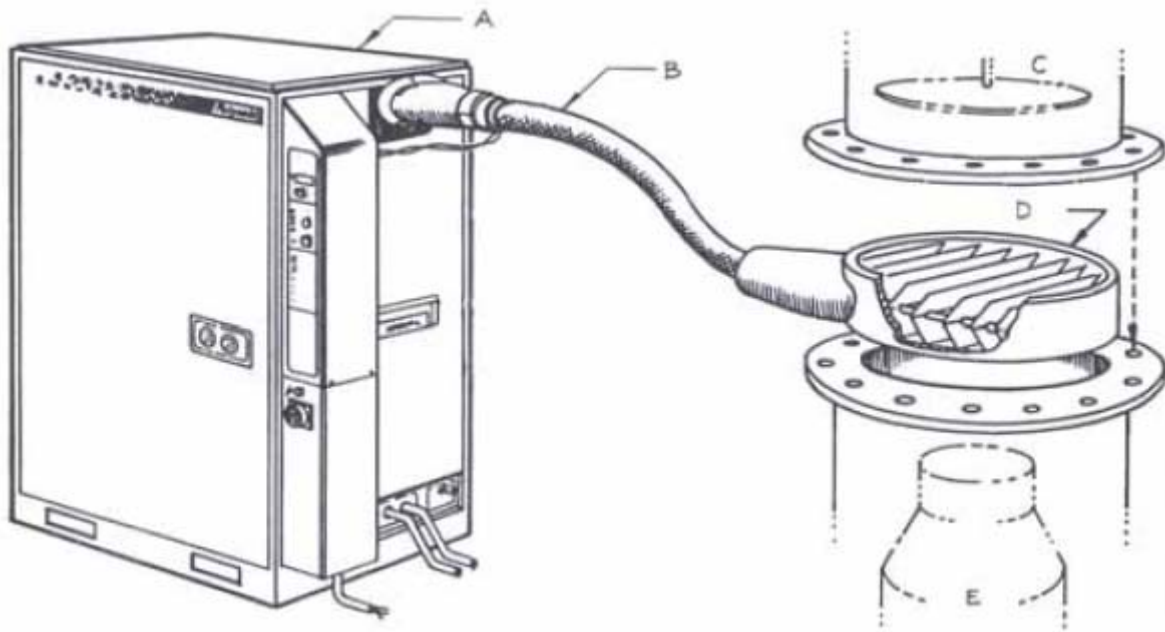

Legend:

- A. Refrigeration Unit
- B. Refrigerant line
- C. High vacuum valve
- D. Cryobaffle
- E. Oil diffusion pump

PFC Versions

The PFC is manufactured in a number of different models and configurations to fit a variety of applications. Table 1 below shows the currently manufactured PFC models.

Table 2 describes the nomenclature used in the PFC model numbering system.

Table 1. Current PFC Models
552 HC
672 HC
1101 LT
1102 HC

Table 2. PFC Model Nomenclature	
Configuration	Explanation
HC	High capacity: increased heat-removal capacity
LT	Low temperature: the cryosurface achieves a lower temperature
Model number ends in “2”, for example “1102”	Designed for European application and bearing the CE mark, these units have refrigerants compliant with EC 1005/2009 the Montreal protocol, and the U.S. EPA/SNAP 
PFC/PFC	Has two refrigerant circuits with combined heat-removal capacity of a standard model with one circuit. Each circuit serves a separate cryosurface, and both cryosurfaces can be quickly defrosted.
PFC/P	Like the PFC/PFC, the PFC/P has two refrigerant circuits. However, the second refrigerant circuit does not have the quick defrost function.

Note: If the PFC includes the following options, please reference the table below:

Description	Addendum Number
DTS communication	825147-01
Lifting Eyes	825153-00

If viewing the manual on CD, see the Addendums folder for PDF copies.

PFC Performance Specifications

Table 3 compares the performance specifications of four models of the PFC. This table is intended to be representative of the PFC product family. For more information about specific PFC models, contact Brooks Automation Polycold Systems.

Table 3. PFC Models Performance Specifications				
Performance¹	1101-LT	552HC	672HC	1102HC
Maximum load (watts at warmest temperature)	800	1,000	1,500	3,600
Theoretical maximum pumping speed (l/sec) ²	74,5000	74,5000	104,300	298,000
Conservative pumping speed, in chamber (l/sec) ²	50,000	50,000	70,000	200,000
Ultimate operating pressure, torr (mbar) ³	2×10^{-12} (3×10^{-12})	2×10^{-9} (3×10^{-9})	5×10^{-9} (7×10^{-9})	3×10^{-8} (4×10^{-8})
Maximum pump start pressure, (atm) ⁴	1	1	1	1
Time to defrost, minutes ⁵	4.0	4.0	4.0	7.0
Total cryocoil surface area m ² (ft ²)	0.5 (5.4)	0.5 (5.4)	0.7 (7.5)	2.0 (21.6)
Refrigerant Lines and Cryocoils				
Standard line length, m (ft)	2.44 (8)	2.44 (8)	2.44 (8)	2.44 (8)
Single-circuit Tube O.D., mm (in)	12 (1/2)	12 (1/2)	16 (5/8)	16 (5/8)
Single-circuit Tube length, m (ft)	13.3 (41.1)	13.3 (41.1)	14 (46)	40 (132)
Dual-circuit Tube O.D., mm (in)	10 (3/8)	10 (3/8)	12 (1/2)	16 (5/8)
Dual-circuit Tube length per coil, m (ft)	7.96 (27.4)	7.96 (27.4)	9.28 (29)	20 (66)
Continued on next page				

Footnotes:

¹Standard conditions for performance testing:

Cryocoil environment at 20°C

Recommend cryocoils and line lengths

Cooling water temperature between 25° and 28°C

Operation at 60 Hz

²Larger cryocoils may give greater pumping speeds, and can be used in some applications. Contact your sales representative or the factory for application details.

³Standard cryocoil at 25% of maximum pumping speed

⁴Recommended cryopump start pressure is near normal “crossover.” Mechanical roughing pumps and blowers are generally more effective for moisture above 1 torr.

⁵Estimated time depending upon cryocoil mass.

PFC Performance Specifications, Continued

Table 4. PFC Models Performance Specifications, Continued				
Parameter	1101 LT	552 HC	672 HC	1102 HC
Utilities				
Cooling water flow rate, l/min. (gal/min.)				
At 13 C (55 F)	11.6 (3.1)	4.9 (1.3)	6.8 (1.8)	13.6 (3.6)
At 26 C (79 F)	29.2 (7.7)	12.3 (3.2)	17.3 (4.6)	33.8 (8.9)
At 29 C (85 F)	46.7 (12.3)	19.7 (5.2)	27.6 (7.3)	54.1 (14.3)
Power input at max. load, kW	15.8	6.0	8.3	19.2
Nominal power requirements ⁵	200/3/50/60			
	230/3/60			
	380/3/50			
	400/3/50			
	460/3/60			
	480/3/60			
Max. operating sound level, dB(A) ⁶	73	71	72	73
Min. room volume, m ³ (ft. ³) ⁷	13 (460)	13 (460)	16 (570)	27 (955)

Footnotes:

⁵For nominal power requirements not on the table, please contact the factory. Please refer to the manual for operating voltage ranges. For 480 volt operation, the maximum voltage is 506 VAC.

⁶Units were tested in a manufacturing environment while under maximum load in the COOL mode.

⁷To comply with the Safety Code for Mechanical Refrigeration, ANSI/ASHRAE-125-1994, the following units should be located in a room no smaller than listed.

7.0 minute maximum defrost is for a 2 m² coil. Most applications use smaller coils and achieve shorter defrost times. A 1 m² coil with standard refrigerant lines will defrost in less than 4 minutes.

Note: All units have cryocoils that may be decoupled from the refrigerant lines and remote control capability with built-in remote connector. Maximum angle of inclination for shipping or handling all units is forty-five degrees (45°).

Using this Manual

This Operation Manual contains operation, safety, and specifications information for the PFC. While this document covers specific information and adjustments for the PFC, there is installation, maintenance, troubleshooting, and repair information in other manuals which can affect the settings or operating mode of the PFC and attached components.

This is especially true for PFCs that are part of a complete system. In such cases, the PFC may be set to system specifications and acceptance tested with the system. Before adjusting or changing settings on a PFC that is part of a system, consult all appropriate system documentation.

Pressures are stated as gauge (i.e., psig) not absolute. Psig is pounds per square inch gauge and kPa is Kilopascals gauge.

$$\text{kPa} = 6.895 \times \text{Psig}$$

$$\text{bar} = \text{Psig} \div 14.5$$

All documents cited in this manual are the latest revision, as of the publication date of this manual. This manual is intended to provide information about a wide variety of PFC configurations and options. It may contain references to items not installed on a specific system.

2. Safety

Overview

This chapter describes safety guidelines, alerts, and labels for the PFC. All personnel involved in the operation or maintenance of the PFC must be familiar with the safety precautions outlined in this section.

These safety recommendations are basic guidelines. If the facility where the PFC is installed has additional safety guidelines, they should be followed as well, along with the applicable national and international safety codes.

If any additional safety-related upgrades or newly identified hazards associated with the PFC are identified, the Technical Support group will notify the owner of record with a Technical Support Bulletin (TSB).

The PFC has been designed to conform to all known safety requirements applicable to our products. Under normal operation the PFC presents no hazard to its operator or other personnel. Access panels require tools for their removal, thus shielding operators and other personnel working in the area of the equipment from the operation or possible failure of the components of the PFC.

Only qualified service personnel are authorized to open or remove the panels and must work in accordance with the safety instructions presented in this chapter and throughout this manual. In service and repair operations, the following hazards may exist:

- Electrical shock
- Hazardous Materials
- Lifting Hazards
- Cold Surfaces
- Hot Surfaces

The information and instructions provided in this chapter and throughout this manual are intended to help service personnel work with the equipment in a safe, effective, and efficient manner. The emergency and safety procedures are provided to help service personnel develop safe practices and establish safe conditions for working with the PFC.

Brooks Automation assesses the safety of each product we manufacture. The safety issues generated during the PFC assessment are discussed in this manual. The complete Safety Analysis is available upon request.

Only qualified personnel are permitted to transport, assemble, operate, or maintain the PFC. Properly qualified personnel are those who have received certified training and have the appropriate qualifications for their jobs, according to local standards.

Safety Alerts Defined

Danger, Warning, and Caution alerts are integral parts of this manual and are also located on, and in, the PFC. Danger, Warning, and Caution alerts must be read carefully, understood thoroughly, and observed at all times. If this equipment is used in a manner not specified, the protection provided by the equipment may be impaired. Pictorial hazard alerts affixed to the PFC are in accordance with ANSI, FDA, SEMI, and (where applicable) IEC standards. Pictorial hazard alerts follow the format shown in Figure 3.

Table 5 describes what the different safety alerts look like.

Figure 3. Description of a Hazard Alert

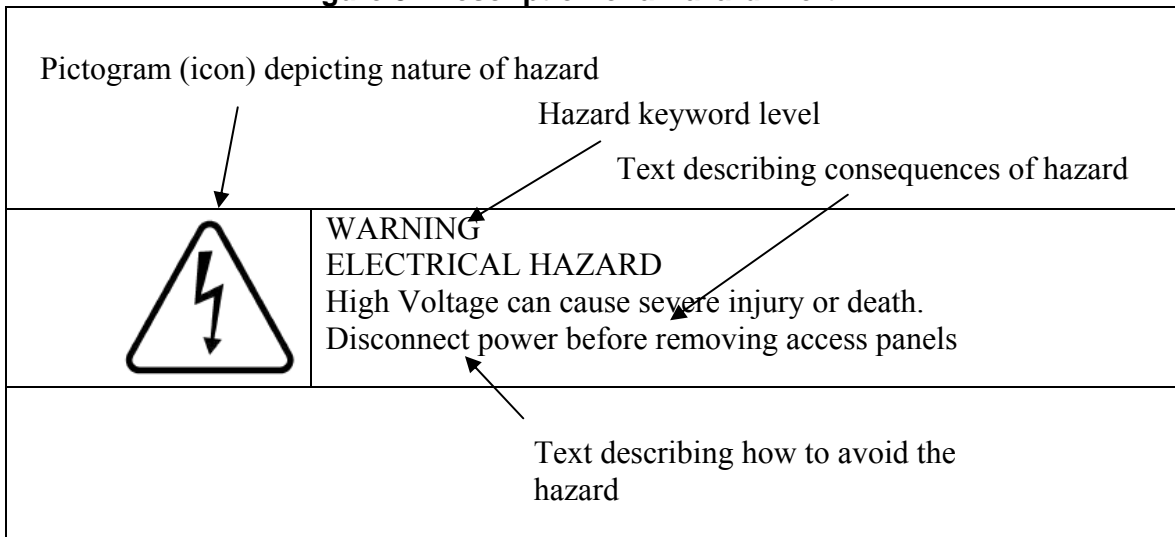







Table 5. Warning Label Legend

DANGER - White Lettering / Red Background (Safety Red: per ANSI Z535.4 - 15 parts Warm Red, 1 part Rubine Red, 1/4 part Black)	White Triangle / Red Exclamation Point
WARNING - Black Lettering / Orange Background (Safety Orange: per ANSI Z535.4 - 13 parts Yellow, 3 parts Warm Red, 1/4 part Black)	Black Triangle / Orange Exclamation Point
CAUTION - Black Lettering / Yellow Background (Safety Yellow: per ANSI Z535.4 - Pantone 108C)	Black Triangle / Yellow Exclamation Point

Continued on next page

Safety Alerts Defined, Continued

Preview and understand the safety alerts used in this manual before operating or performing any work on the PFC. Safety warnings are provided in this manual before each step that may involve hazards to personnel. See the following safety alert icons and text for information on icons, which identify potentially hazardous situations/consequences of not avoiding the hazard. Safety alerts used in the manual and on the equipment follow ANSI Z535 and use the signal words **DANGER**, **WARNING** or **CAUTION**.





Table 6. Safety Alerts Defined	
Alert	Description
Note:	A note provides additional or explanatory information. No pictorial is used.
CAUTION	CAUTION without a safety alert symbol indicates a potentially hazardous situation which, if not avoided, could result in property damage.
	CAUTION indicates a potentially hazardous situation which, if not avoided, may result in minor or moderate injury. It may also be used to alert against unsafe practices.
	WARNING indicates a potentially hazardous situation which, if not avoided, could result in serious injury or death.
	DANGER indicates an imminently hazardous situation which, if not avoided, will result in serious injury or death. This alert is limited to the most extreme situations.
	RISK OF ELECTRIC SHOCK
	FIRE HAZARD

Continued next page

Safety Precautions for the PFC

General Safety Precautions

The following safety alerts apply specifically to the PFC. Read and understand them before performing any adjustments or service on the PFC.

	<p>WARNING</p> <p>GENERAL HAZARD</p> <p>Failure to review this manual could result in death or serious injury. Review this manual before performing any procedure including routine operation of Brooks Polycold PFC.</p>
	<p>CAUTION</p> <p>GENERAL HAZARD</p> <p>United States federal law requires a certified refrigeration technician (Type 2, High Pressure) for any procedure that could release refrigerant to the atmosphere. This includes installing the cryopump, some inspection procedures, disconnecting the refrigerant lines, some troubleshooting procedures, repair, and disposal of the unit. A qualified refrigeration technician must do all refrigeration work.</p>
	<p>WARNING</p> <p>GENERAL HAZARD</p> <p>When installing or servicing the PFC outside of the United States, comply with all applicable local laws and regulations regarding this type of equipment.</p>
	<p>WARNING</p> <p>ELECTRICAL</p> <p>Failure to have a qualified electrician perform all of the electrical work on the PFC can result in death or serious injury. A qualified electrician must perform all of the electrical work on the PFC.</p> <p>Do not reach inside the refrigeration unit after the unit has been connected to an electrical power source.</p>

Continued on next page

Safety Precautions for the PFC, Continued

General Safety Precautions, Continued

	DANGER
	<p>GENERAL HAZARD</p> <p>Do not bypass or change the setting of any protective devices. Resetting of a protective device may void the warranty and, if not avoided, may cause death or serious injury.</p> <p>Review this manual before performing any procedure including routine operation of Polycold's <i>Cool Solutions</i>® Fast Cycle Water Vapor Cryopump. Observe the following.</p> <p>Also, reset protective devices only as defined throughout this manual.</p>

Specific Hazards and how to Avoid Them

	WARNING
	<p>FLAMMABLE MATERIAL (PFC 1101 ONLY)</p> <p>Do not open the refrigerant circuit to the atmosphere. Do not change the settings of the valves or loosen any fittings. Opening the refrigerant circuit or changing valve settings along with the failure to following instructions in this manual could result in death or serious injury.</p> <p>Review this manual before performing any procedure including routine operation of the PFC. Inspect the refrigerant circuit and change valve settings only as defined throughout this manual.</p>

	CAUTION
	<p>GENERAL HAZARD</p> <p>Do not connect the refrigeration unit to an existing cryosurface unless it meets specifications for this interconnection. Doing so could cause minor or moderate injury.</p>

Continued on next page



Safety Precautions for the PFC, Continued

Specific Hazards and how to Avoid Them, Continued

Refrigerant is harmful to the environment and to human health. Refrigerant in 1101 models may also be flammable.

	WARNING
	<p>CHEMICAL HAZARD</p> <p>Do not release refrigerant to the atmosphere. Opening the refrigerant circuit or changing valve settings along with the failure to following instructions in this manual could result in death or serious injury.</p> <p>Review this manual before performing any procedure including routine operation of Polycold's <i>Cool Solutions</i>® Fast Cycle Water Vapor Cryopump. Do not release refrigerant to the atmosphere.</p>

	CAUTION
	<p>GENERAL HAZARD</p> <p>Failure to review this manual may result in minor or moderate injury. See the enclosed Material Safety Data Sheet (MSDS) section for additional information and protective measures for Polycold's <i>Cool Solutions</i>® Fast Cycle Water Vapor Cryopump.</p>

 	CAUTION
	<p>EXTREME TEMPERATURES EXIST</p> <p>Extreme temperatures (cold and hot) exist while the refrigeration unit is operating and for at least an hour after the unit is turned off. Contact with a cold or hot surface may result in minor or moderate injury.</p> <p>Do not touch any uninsulated part of the refrigerant circuit when the unit is operating. This includes the solenoid and hand valves, any uninsulated part of the refrigerant line or feedthrough, and the cryosurface. Also, do not reach inside Polycold's <i>Cool Solutions</i>® Fast Cycle Water Vapor Cryopump's refrigeration unit.</p>

	CAUTION
	<p>GENERAL HAZARD EXISTS</p> <p>Moving or repositioning the refrigerant line may result in minor or moderate injury.</p> <p>Do not attempt to move or position the refrigerant line. The insulation hardens when cold and may crack.</p>

Safety Guidelines

Safe use and service of the PFC requires that operators and service people observe the following:

- Service personnel should understand the operation of process-related hardware interlocks, and the sequences of hardware operation that are executed automatically, as explained in this manual.
- The PFC should not be used without assuring correct operation of all connected facilities, especially fugitive emissions exhaust.
- Service personnel should always assume that high voltage is present unless they have personally turned it off and locked it out.
- The equipment should not be operated without all guards and safety devices in place.
- The equipment should be shutdown, locked-out, and not be operated while it is being maintained.
- Users should not attempt to defeat, modify, or disable any of the equipment's safety interlock switches.
- Only Polycold Systems trained service personnel should perform installation, assembly, operation, disassembly, service, or maintenance of the PFC.
- All safety related incidents or near misses should be reported to a supervisor or to Brooks Polycold Systems Inc.
- The user should carefully review and understand manufacturer provide material safety data sheets (MSDS) for materials used by this equipment.
- If hazardous materials will be present, users must observe the proper safety precautions and ensure that the material used is compatible with those from which the PFC is fabricated.
- Provide detection of unwanted chemical or gaseous releases.
- Determine if the PFC will be employed in an earthquake-prone environment and install the equipment accordingly.
- Do not place the PFC's facilities connections (power and communications cables and vacuum lines) where they could cause a trip hazard.
- Do not place the PFC in a location where it may be subject to physical damage.
- Ensure that the power connection to the PFC is properly grounded.
- Ensure that the PFC receives unhindered air flow for cooling.
- Do not remove safety labels or equipment identification labels.
- Turn OFF power before inserting or removing power cables.
- Be aware of the hazardous points of the PFC as described in this chapter.
- Use of the PFC for any purpose other than as a compact cooler is not recommended and may cause damage to the PFC or the equipment it is connected to.
- Whenever power is applied to the compressor unit, the fans operate. Take care when working inside the compressor unit when it is energized.
- Always operate the PFC with the covers in place.
- Do not install or operate the PFC if it has been dropped, damaged, or is malfunctioning.
- Do not immerse cables or connectors in liquid.
- Keep cables and connectors away from heated surfaces.

Equipment Guidelines

The following guidelines are provided to aid in the use and service of the PFC.

- Brooks Automation Technical Support will issue a Technical Support Bulletin (TSB) to notify the owners of record of any field retrofits.
- Contact Brooks Automation Customer Support for information regarding repair and maintenance service policies, both during the production of the PFC and after production is discontinued.
- Any user-caused damage during integration of the PFC into their equipment is the user's responsibility.
- Brooks Automation's responsibility for work performed by Brooks authorized technicians or for equipment transported or resold by the owner of record is determined on a case-by-case basis by Brooks Automation Technical Support.
- Any parts being returned to Brooks Automation should be packaged according to the instructions provided with the replacement part. Packing instructions for shipping the PFC are provided in the Appendix.

Brooks Automation provides training for the Polycold PFC. Only qualified, properly trained persons should perform any procedures on the PFC. Damage resulting from improperly performing a procedure or not following cautions is not covered under warranty or service agreements.

Continued on next page

Equipment Guidelines, Continued

Personnel Safety Guidelines

The PFC may provide several direct safety hazards to personnel if not properly installed or operated. Adhere to the following safety guidelines:

- Persons operating the PFC should be properly trained.
- Know the location of the following:
 - Fire extinguisher
 - First Aid Station
 - Emergency eyewash and/or shower
 - Emergency exit
- Use the following safety equipment (if necessary), according to the manufacturer's instructions, prior to installing, operating, or servicing the PFC:
 - Eye protection
 - Safety Shoes; shoes with protective toes should be worn to protect feet from dropping tools or parts.
- Observe the facility guidelines pertaining to loose clothing while working around or operating the PFC.
- Read and understand the Material Safety Data Sheets (MSDS) for the refrigerant used with the PFC.
- It may be recommended that the use of hazardous materials, such as cleaning fluids, be used during routine maintenance procedures. Read and understand the facility's MSDS (provided by the manufacturer) for each substance.
- Ergonomic hazards may exist with certain operations pertaining to the PFC.

SEMI S2-0200 Electrical Work Types

For the purpose of classifying the safety level of working on semiconductor electrical equipment, SEMI safety standard S2-0200 defines the following four levels:

Type 1- Equipment is fully de-energized.

Type 2- Equipment is energized. Energized circuits are covered or protected.





Note: Type 2 work includes tasks where the energized circuits are or can be measured by placing probes through suitable openings in the covers or insulators.

Type 3- Equipment is energized. Energized circuits are exposed and inadvertent contact with uninsulated energized parts is possible. Potential exposures are no greater than 30 volts rms, 42.4 volts peak, 60 volts dc or 240 volt-amps in dry locations.

Type 4- Equipment is energized. Energized circuits are exposed and inadvertent contact with uninsulated energized parts is possible. Potential exposures are greater than 30 volts rms, 42.4 volts peak, 60 volts dc or 240 volt-amps in dry locations. Potential exposures to radio-frequency currents exist; refer to SEMI S2-0200, Table A5-1 of Appendix 5 for a listing of these values.

Standard Symbols on the Equipment

The following safety symbols are affixed to the PFC compressor unit.

	Caution: risk of electrical shock
	Caution: refer to accompanying documents
	On
	Off
	Protective conductor (ground) conductor

Safety Labels on the PFC

Safety labels are located on the exterior and interior of the PFC. This section identifies all the safety labels and their locations on and in the PFC.

The safety labels are numbered in the PFC photographs. Following the photographs are tables that describe the safety labels.

Figure 4. PFC External Safety Labels, Front

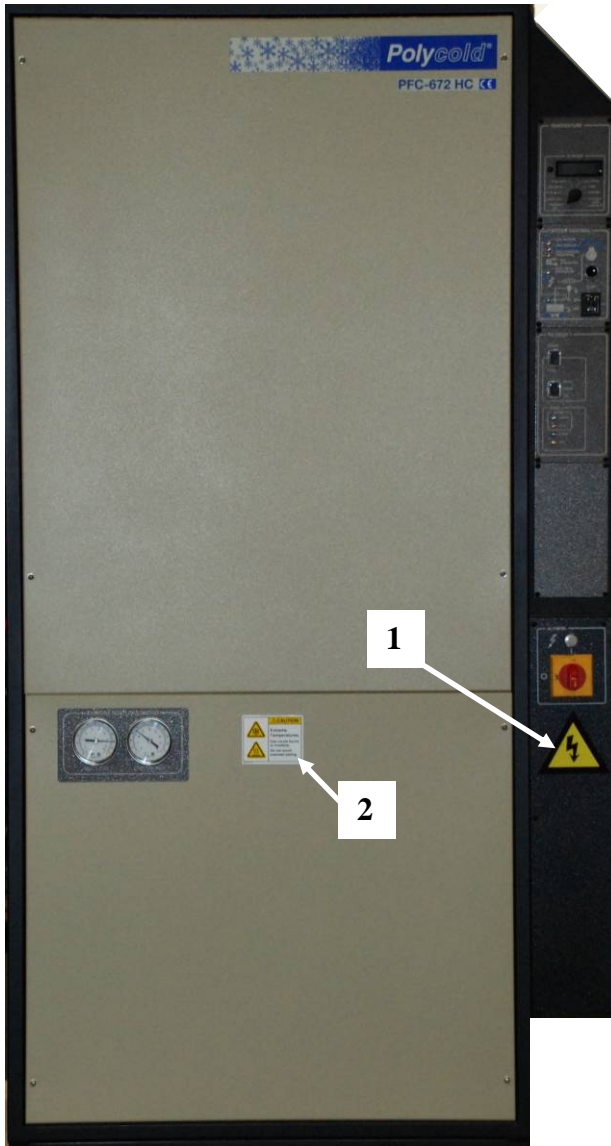

Information for Numbered Items

1 and 2 = Table 7 on page 24

Continued on next page

Safety Labels on the PFC, Continued

Figure 5. PFC External Safety Labels, Right Side

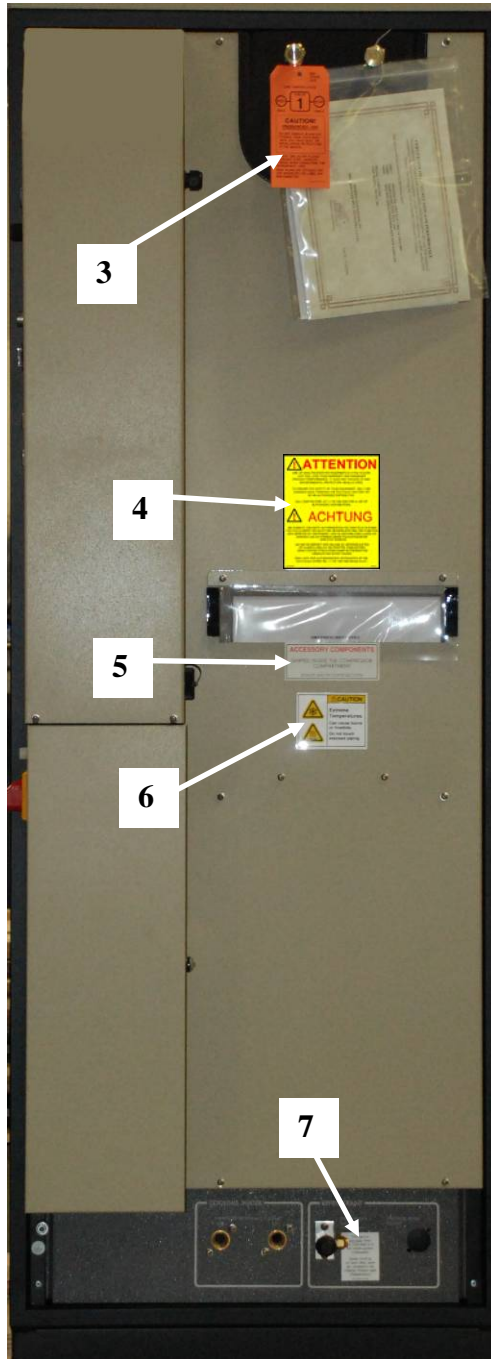

Information for Numbered Items

- 3 = Table 8 on page 25
- 4 = Table 9 on page 26
- 5 and 7 = Table 10 on page 27
- 6 = Table 7 on page 24

Continued on next page

Safety Labels on the PFC, Continued



Figure 6. PFC External Safety Labels, Rear (left side label is the same type and location)



**Information for Numbered
Items**
8 = Table 7 on page 24



Continued on next page

Safety Labels on the PFC, Continued

Table 7. PFC External Labels	
Location	Description
<p>#1</p> <div style="text-align: center;">  </div>	<p>Main ON/OFF switch and lock-out/tag-out location for unit.</p> <p>Contact Brooks Automation Polycold Systems for a replacement part number</p>
<p>#2, 6, and 8</p> <div style="text-align: center;">  </div>	<p>Extreme temperatures.</p> <p>P.N. 407114-00</p>

Continued on next page

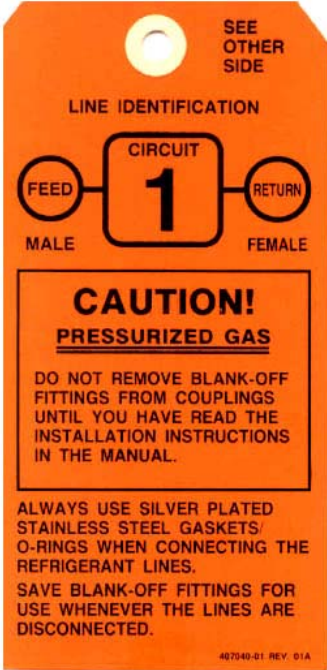
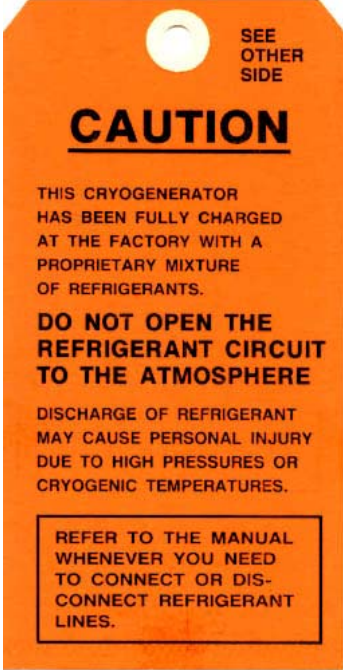
Safety Labels on the PFC, Continued

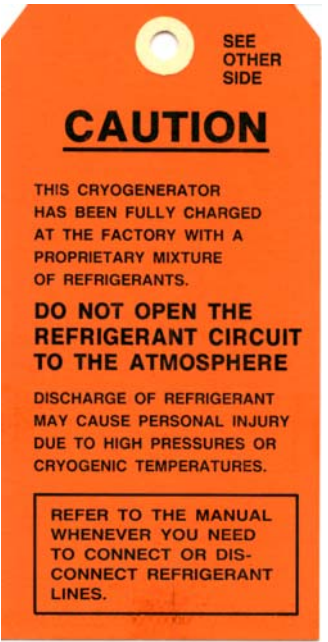
Table 8. PFC External Labels, Continued		
Location		Description
#3	<div style="display: flex; justify-content: space-around;"> <div style="text-align: center;"> <p>Side 1</p>  </div> <div style="text-align: center;"> <p>Side 2</p>  </div> </div>	<p>Line identification and pressurized gas warning.</p> <p>P.N. 407040-01</p>
#3	<div style="display: flex; justify-content: space-around;"> <div style="text-align: center;"> <p>Side 1</p>  </div> <div style="text-align: center;"> <p>Side 2</p>  </div> </div>	<p>Line identification and pressurized gas warning.</p> <p>P.N. 407040-02</p> <p>Note: This tag is attached to the Feed line of Circuit 2 of dual-circuit (PFC/PFC) refrigeration units prior to shipping.</p>

Continued on next page

Safety Labels on the PFC, Continued

Table 9. PFC External Labels, Continued	
Location	Description
<p>#4</p> 	<p>Warning regarding use of unauthorized refrigerants.</p> <p>P.N. 407192-00</p>

Continued on next page

Safety Labels on the PFC, Continued

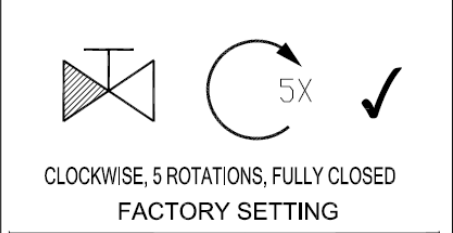
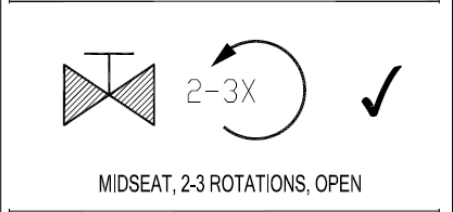
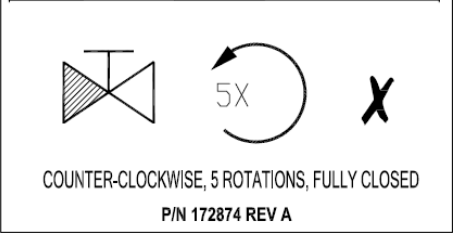
Table 10. PFC External Labels, Continued	
Location	Description
<p>#5</p>	<p>This is not a safety label. This label identifies the location of the accessory components.</p>
<p>#7</p> <div style="border: 1px solid black; padding: 10px; margin: 10px 0;">    </div>	<p>Evacuation valve opening instruction</p> <p>P.N. 172874</p>

Continued on next page

Safety Labels on the PFC, Continued

Figure 7. PFC 672 Internal Safety Labels, Front



Continued on next page

Safety Labels on the PFC, Continued

Figure 8. PFC 672 Internal Safety Labels, Rear

Information for numbered items
2 and 3 = Table 11 on page 37
4 = Table 12 on page 38

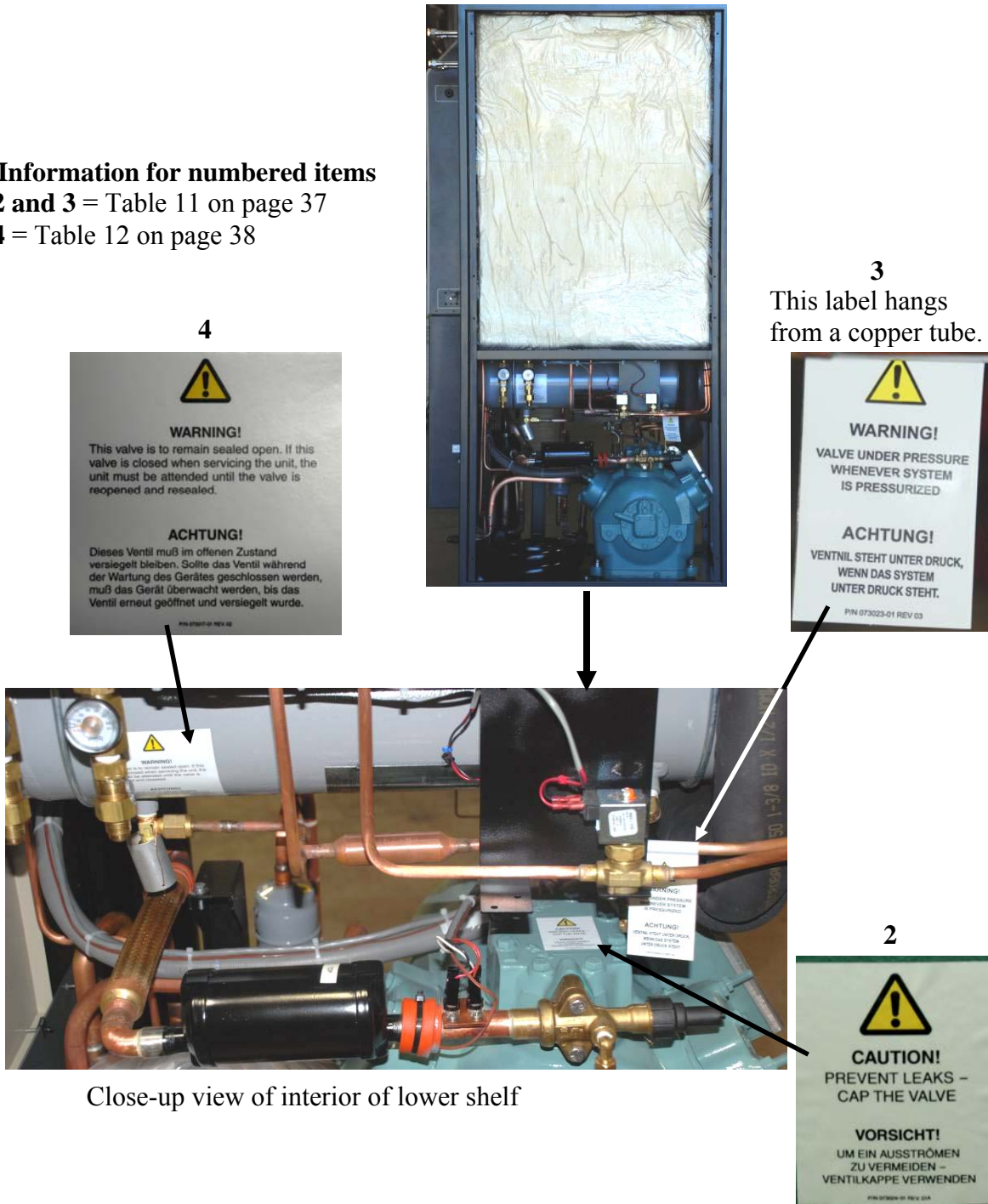

4

WARNING!
This valve is to remain sealed open. If this valve is closed when servicing the unit, the unit must be attended until the valve is reopened and resealed.

ACHTUNG!
Dieses Ventil muß im offenen Zustand versiegelt bleiben. Sollte das Ventil während der Wartung des Gerätes geschlossen werden, muß das Gerät überwacht werden, bis das Ventil erneut geöffnet und versiegelt wurde.

P/N 073023-01 REV 03

3
This label hangs from a copper tube.

WARNING!
VALVE UNDER PRESSURE
WHENEVER SYSTEM
IS PRESSURIZED

ACHTUNG!
VENTNIL STEHT UNTER DRUCK,
WENN DAS SYSTEM
UNTER DRUCK STEHT.

P/N 073023-01 REV 03

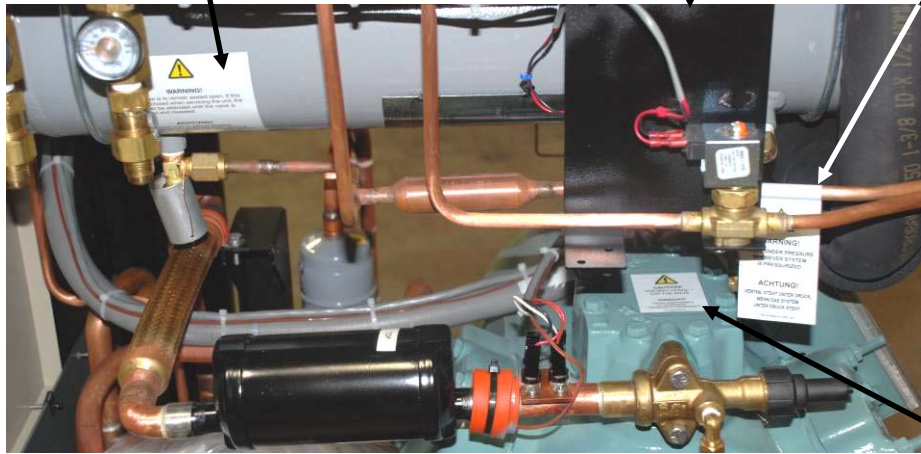

Close-up view of interior of lower shelf

2

CAUTION!
PREVENT LEAKS -
CAP THE VALVE

VORSICHT!
UM EIN AUSSTRÖMEN
ZU VERMEIDEN -
VENTILKAPPE VERWENDEN

P/N 073023-01 REV 03

Continued on next page

Safety Labels on the PFC, Continued

Figure 9. PFC 672 Internal Labels, Left Side

Information for numbered items
5 = Table 12 on page 38

5



Continued next page

Safety Labels on the PFC, Continued

Figure 10. PFC 1102 Internal Safety Labels, Front

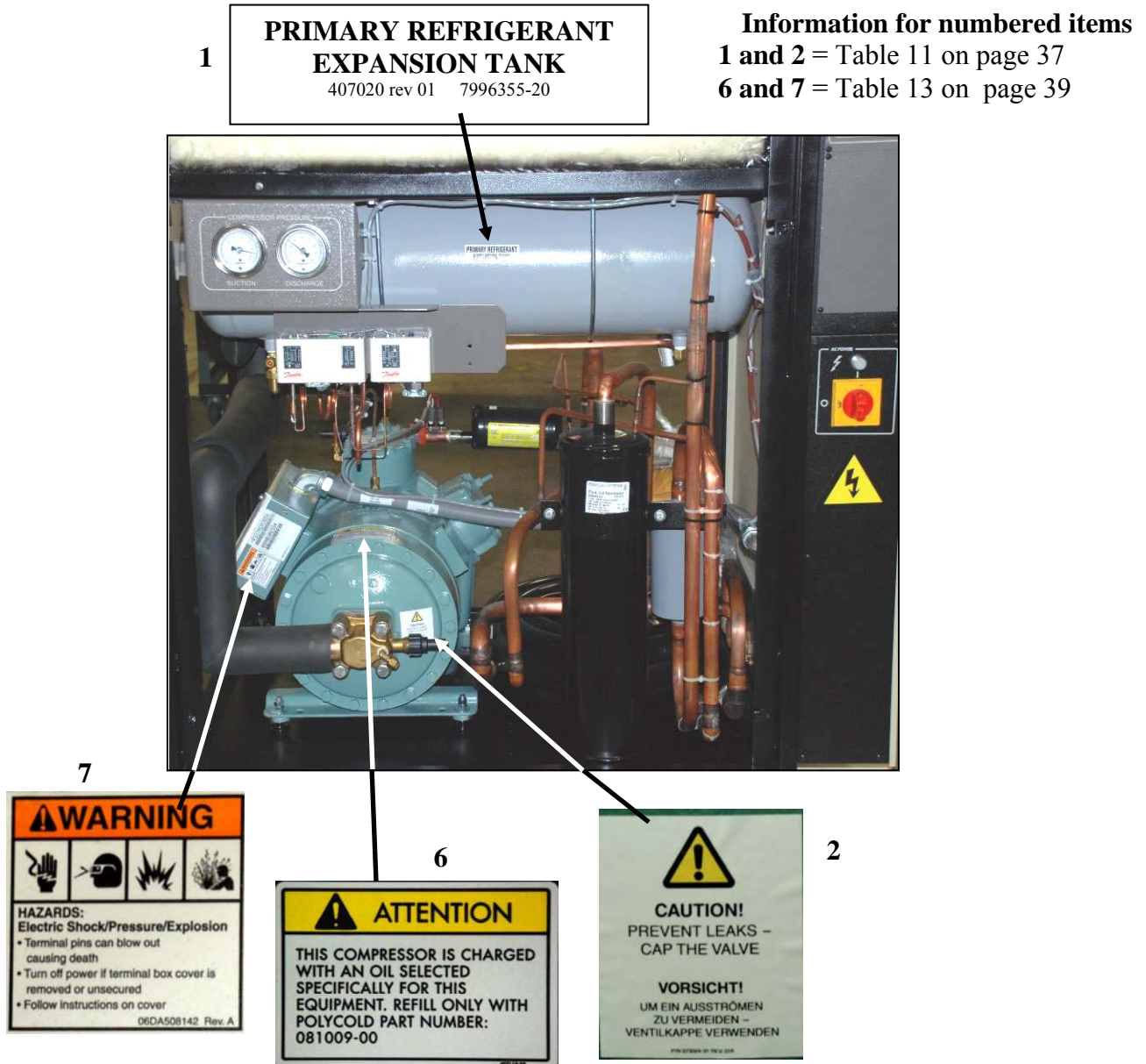

Continued next page

Safety Labels on the PFC, Continued

Figure 11. PFC 1102 Internal Safety Labels, Rear

Information for numbered items

3 = Table 11 on page 37

4 = Table 12 on page 38

3



4



Continued next page

Safety Labels on the PFC, Continued

Figure 12. PFC 1102 Internal Safety Labels, Left Side





Information for numbered items
5 = Table 12 on page 38

5



Continued next page

Safety Labels on the PFC, Continued

Table 11. PFC Internal Safety Labels	
Location	Description
<p>#1</p> <div style="border: 1px solid black; padding: 10px; text-align: center;"> <p>PRIMARY REFRIGERANT EXPANSION TANK 407020 rev 01 7996355-20</p> </div>	<p>Identifies the primary refrigerant expansion tank.</p> <p>P.N. 407020 rev 01, 7996355-20</p>
<p>#2</p> 	<p>Instruction to cap the valve in order to prevent leaks.</p> <p>P.N. 073024-01</p>
<p>#3</p> 	<p>Warning that the designated valve is under pressure when the system is pressurized.</p> <p>P.N. 073023-01</p>

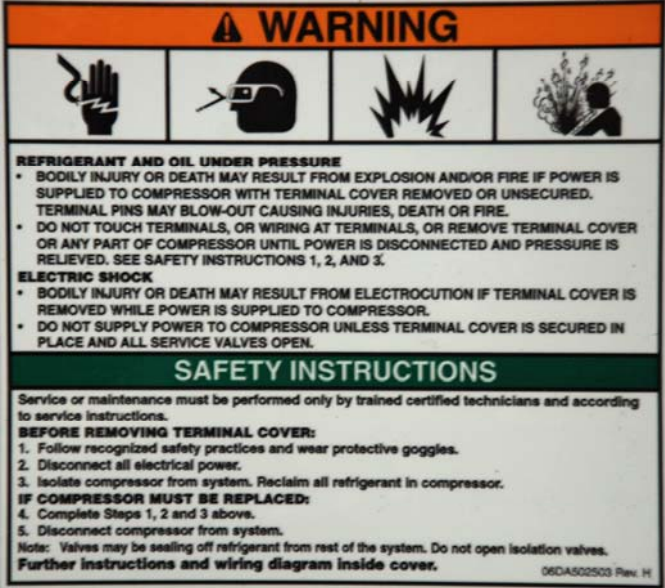

Continued next page

Safety Labels on the PFC, Continued

Table 12. PFC Internal Safety Labels, Continued	
Location	Description
<p>#4</p>  <p>The label features a yellow triangular warning symbol with a black exclamation mark. Below it, the word "WARNING!" is printed in bold. The text reads: "This valve is to remain sealed open. If this valve is closed when servicing the unit, the unit must be attended until the valve is reopened and resealed." Below this, the German word "ACHTUNG!" is printed in bold, followed by the German translation: "Dieses Ventil muß im offenen Zustand versiegelt bleiben. Sollte das Ventil während der Wartung des Gerätes geschlossen werden, muß das Gerät überwacht werden, bis das Ventil erneut geöffnet und versiegelt wurde." At the bottom, it says "P/N 073017-01 REV. 02".</p>	<p>Warning to leave the designated valve open.</p> <p>P.N. 073017-01</p>
<p>#5</p>  <p>The label has an orange header with a warning symbol and the word "WARNING". Below the header are four icons: a hand being struck by a lightning bolt, a person wearing safety goggles, a flame, and a person being sprayed with liquid. The text includes: "REFRIGERANT AND OIL UNDER PRESSURE", "BODILY INJURY OR DEATH MAY RESULT FROM EXPLOSION AND/OR FIRE IF POWER IS SUPPLIED TO COMPRESSOR WITH TERMINAL COVER REMOVED OR UNSECURED. TERMINAL PINS MAY BLOW-OUT CAUSING INJURIES, DEATH OR FIRE.", "DO NOT TOUCH TERMINALS, OR WIRING AT TERMINALS, OR REMOVE TERMINAL COVER OR ANY PART OF COMPRESSOR UNTIL POWER IS DISCONNECTED AND PRESSURE IS RELIEVED. SEE SAFETY INSTRUCTIONS 1, 2, AND 3.", "ELECTRIC SHOCK", "BODILY INJURY OR DEATH MAY RESULT FROM ELECTROCUTION IF TERMINAL COVER IS REMOVED WHILE POWER IS SUPPLIED TO COMPRESSOR.", "DO NOT SUPPLY POWER TO COMPRESSOR UNLESS TERMINAL COVER IS SECURED IN PLACE AND ALL SERVICE VALVES OPEN.", "SAFETY INSTRUCTIONS", "Service or maintenance must be performed only by trained certified technicians and according to service instructions.", "BEFORE REMOVING TERMINAL COVER:", "1. Follow recognized safety practices and wear protective goggles.", "2. Disconnect all electrical power.", "3. Isolate compressor from system. Reclaim all refrigerant in compressor.", "IF COMPRESSOR MUST BE REPLACED:", "4. Complete Steps 1, 2 and 3 above.", "5. Disconnect compressor from system.", "Note: Valves may be sealing off refrigerant from rest of the system. Do not open isolation valves.", "Further instructions and wiring diagram inside cover.", "06DA502503 Rev. H"</p>	<p>Refrigerant and oil warning.</p>

Continued next page

Safety Labels on the PFC, Continued

Table 13. PFC Internal Safety Labels, Continued	
Location	Description
<p>#6</p> 	<p>Compressor oil notice.</p> <p>P.N. 407119-00</p>
<p>#7</p> 	<p>Electrical hazards</p>

Safety and Operational Interlocks

Safety interlocks function to protect personnel safety, and operational interlocks to protect the Polycold PFC. The PFC contains the interlocks shown in Table 14.

The interlocks are covered in more detail in the Operation section of this manual.

Table 14. Safety and Operational Interlocks in the Polycold PFC

Interlock	Function
Pressure Relief valve	A controlled-release point for the refrigerant in case the pressure of the refrigerant exceeds a safe point. The relief valve provides a means to reduce high pressures in a manner that does not result in an explosion.
Compressor overload switch	<p>Detects when the temperature or current of the PFC compressor unit exceeds a safe temperature, and shuts off the compressor.</p> <p>This switch automatically resets itself when the compressor temperature falls to a safe temperature.</p>
Circuit breaker	A device included on some PFC units which protects against current overload of the compressor motor.
Main Power Switch	On the high voltage box panel. The main power on/off switch for the PFC. This switch includes Lockout / Tagout functionality.

WARNING



Additional interlocks may be implemented by the user at their discretion. Overriding interlocks can result in equipment damage and possible personal injury.

General Hazards

DANGER



HIGH GAS PRESSURE HAZARD. Do not heat pressurized gas lines or other gas charged components. Prevent gas escape when connecting and disconnecting gas lines. Work in a ventilated area.

WARNING



AVOID INJURY AND EQUIPMENT DAMAGE. Operate this equipment as specified in the system manual.

AVOID ELECTRIC SHOCK. All electrical supply equipment must meet applicable codes and be installed by qualified personnel.

AVOID INJURY. Use two wrenches when connecting or disconnecting a gas line coupling to avoid loosening a bulkhead coupling. Gas pressure can project the coupling with enough force to cause injury.

Continued on next page

General Hazards, Continued

WARNING



PREVENT INJURY. Always wear eye protection when handling pressurized gas lines and other pressurized equipment.

EXTREME COLD HAZARD. Prevent frostbite. Do not touch any frosted parts.

AVOID ELECTRIC SHOCK. Only an electrician or other skilled person should troubleshoot electrical problems in the unit. Touching a fully charged capacitor can cause severe electrical shock resulting in injury or death.

AVOID INJURY FROM BURNS. Do not touch surfaces within the unit which may be hot, such as the compressor.

AVOID ELECTRIC SHOCK. Permit only qualified electrical technicians to open electrical enclosures, to perform electrical checks or to perform tests with the power supply connected and wiring exposed. Failure to observe this warning can result in injury or death.

DAMAGE TO GAS LINES can result from crimping by repeated bending and repositioning.

PREVENT INJURY. The PFC compressor unit weighs between 374 kg (825 lbs) and 544 kg (1200 lbs), depending on model. Failure to take the proper precautions before moving it could result in personal injury.

CAUTION



PREVENT EQUIPMENT DAMAGE. De-pressurization and/or exposure to ambient conditions may cause contamination and equipment damage. Only service personnel trained by Brooks Automation Polycold Systems should perform this type of maintenance. Maintenance performed by unauthorized persons will void the warranty.

Continued on next page

General Hazards, Continued

CAUTION



AVOID GAS LEAKS. Keep the gas line couplings aligned when making or breaking a coupling connection. Leaks can occur due to the weight of the gas line or due to a sharp bend near the connection.

MAINTAIN AMBIENT TEMPERATURE. Operating outside the specifications can damage the equipment.

PRESERVE YOUR WARRANTY. Modification to equipment without the consent of the manufacturer will void the warranty.

PREVENT DAMAGE. Install shipping bolts under the compressor unit before shipping. Failure to protect the compressor unit will void the warranty.

SECURE THE UNIT. After installation and adjustment of the unit for operation, secure the unit such that it will remain stable during a seismic event (earthquake).

FOLLOW ALL LOCKOUT/TAGOUT PROCEDURES for your facility when servicing the equipment.

Electrical Hazards

Maximum power consumption for the PFC can be up to 20.8 kVA. The minimum overcurrent ratings for disconnects requires a user-installed circuit breaker that satisfies local electrical code for the voltage and current that supplies the PFC. The user-installed circuit breaker must also meet, or exceed, the minimum AIC rating specified by SEMI S2. Power Supplies converting facility power may be operating at higher levels of AC in close proximity of the PFC.

	WARNING
	<p>ELECTRICAL HAZARD</p> <p>Maximum power consumption for the PFC can be 800 Watts. Turn off power before servicing.</p> <p>Improper electrical connection or connection to an electrical supply can result in electrical shock or burns resulting in serious injury or death or cause an equipment fire and damage to the equipment. Always provide the PFC with the proper electrical code compliant connections.</p>

Safety Interlocks

The PFC safety interlock circuitry design is a positive logic, hardware based, fault tolerant device (approved by an authorized testing agency and NRTL approved for use as a safety device), providing operator notification, requiring manual reset, and which places the equipment in a safe standby condition upon activation. An exception to this is the compressor discharge safety interlock that uses negative logic. The risk associated with this variance has been deemed to be acceptable since other interlocks (which use positive logic) are expected to be activated if abnormally high discharge temperatures occur.

Continued next page

Electrical Hazards, Continued

Circuit Breaker and Fuse Protection

Table 15 lists the circuit breakers and fuses in the PFC.

Table 15. PFC Circuit Breaker and Fuse Protection			
Location	Reference Designation	Protection Provided	Rated Voltage and Amperage
High Voltage Box	CB1	Over current	460 VAC, 1 A
	CB2	Over current	460 VAC, 1 A
	CB3	Over current	24 VAC, 5A
High Voltage Box, 575 VAC Compressor	CB1	Over current	24 VAC, 5 A
	FU1	Over current	600 VAC, 1A
	FU2	Over current	600 VAC, 1A
System Controller Printed Circuit Board	F1	Over current	24 VAC, 1A

Continued on next page

Electrical Hazards, Continued

Table 16. Electrical Hazard Classifications

Classification	Description
<i>Type 1</i>	Equipment is fully de-energized.
<i>Type 2</i>	Equipment is energized. Energized circuits are covered or insulated.
<i>Type 3</i>	Equipment is energized. Energized circuits are exposed and inadvertent contact with un-insulated energized parts is possible. Potential exposures are no greater than 30 volts RMS, 42.2 volts peak; 60 volts DC or 240 volt-amps in dry locations.
<i>Type 4</i>	Equipment is energized. Energized circuits are exposed and inadvertent contact with un-insulated energized parts is possible. Potential exposures are greater than 30 volts RMS, 42.4 volts peak, 60 volts DC, or 240 volt-amps in dry locations.

If a Type 1 procedure (electrically cold) is being performed, lock and tag the equipment by attaching the appropriate locking device on the power distribution point, according to the facility's safety procedures. If no such procedures exist, follow the guidelines provided in Lockout/Tagout (LOTO)

If a Type 2, 3, or 4 procedure is being performed, tag the equipment by attaching the appropriate warning labels at the source of power to the system and on the equipment itself, according to the facility's safety procedures. If no such procedures exist, follow the guidelines provided in

Lockout/Tagout (LOTO)

Standard industry practices regarding lockout/tagout (LOTO) procedures must be followed when service or maintenance is performed on the PFC in order to prevent personal injury or equipment damage. Local or factory standard procedures must also be followed; but where no procedures exist, follow the procedures for LOTO in SEMI S2.

The main power switch on the front of the PFC is designed to be used as a LOTO power switch (see Figure 13). When this switch is in the OFF position, the top of the switch can be swiveled open, revealing the holes where you can put a lock and a tag.

Figure 13. PFC Main Power Switch LOTO Design

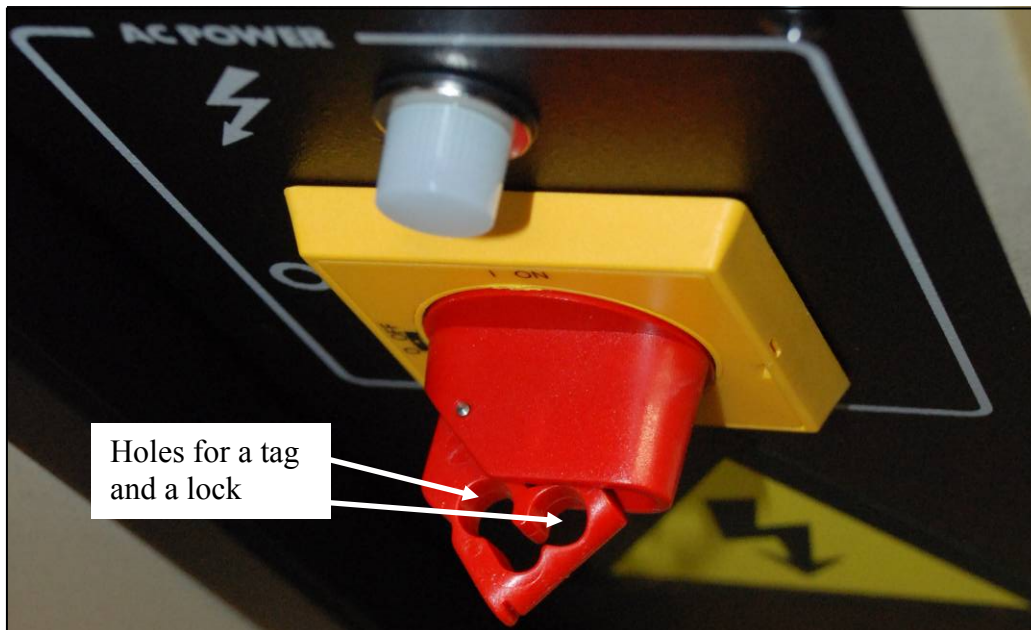

Continued next page

Lockout/Tagout (LOTO), Continued

If a service lock or tag is installed, DO NOT remove the tag or energize the circuit without proper authorization.

	WARNING
	<p>ELECTRICAL HAZARD</p> <p>Contact with energized equipment could cause electric shock and result in death or serious injury. All hazardous energy supplied to the PFC must be disconnected from the PFC according to the facility's lockout/ tagout procedure. Potentially hazardous conditions may exist that can result in personal injury.</p>

All hazardous energy supplied to the PFC must be disconnected from the PFC according to the facility's lockout/ tagout procedure. Potentially hazardous conditions may exist that can result in personal injury.

General Lockout/Tagout Guidelines

When using lockout/tagout procedures, a lock and a tag with a written warning are attached to valves/switches/circuit breakers that are placed in a SAFE or OFF position to keep equipment from being set in motion and endangering service personnel. The SAME person shall remove the lock and tag once the work has been completed. One key is to be provided for each lock and must be kept by the person doing the work. The tag and its attachment shall be substantial enough to avoid accidental removal. The tag and attachment shall be non-reusable, self-locking, non-releasable, and attached by hand. A nylon cable tie is recommended.

Following is a general procedure for Lockout/Tagout:

Table 17. General Lockout/Tagout Procedure	
Step	Action
1.	Prepare to power down the equipment
2.	Shut down the refrigeration unit as described in the Operation section of this Manual.
3.	Locate and switch off the main power source for the refrigeration unit.
4.	Apply the lockout device and tagout label.
5.	If there are any large capacitors in the unit that may pose a danger to your work, discharge any stored energy in a safe manner.
6.	Use an electrical meter or test device to verify that the equipment is safe to work on. Proceed with your work when you have determined the unit is safe to work on.
7.	When you have finished working on the unit, remove the lockout device and tagout label, and restore the unit to operation.
End of procedure	

Continued on next page

Lockout/Tagout (LOTO), Continued

Removal of Locks and Tags

Before lockout/tagout devices are removed and electrical power is restored to the equipment, the authorized employee must take the following actions:

- Inspect the work area to ensure that non-essential items have been removed and that components are intact and capable of operating properly.
- Check the area around the equipment to ensure that all employees have been safely positioned or removed.
- Locks and tags should only be removed by those employees who attached them. Notify affected employees immediately after removing locks and tags and before starting equipment.

Gas Hazards



DANGER

Harmful gases may reside in the system. Under certain circumstances, some gases can leave a flammable or poisonous residue. Refer to the facility's Material Safety Data Sheets (MSDS) for these gases and follow the facility's standard precautions prior to performing any routine maintenance.

Exposure to gases used in the PFC or related equipment may cause dizziness or suffocation in unventilated areas.

Personal protective equipment such as gloves, eye wear, respirators, self-contained breathing apparatus, etc. may be required when working on the PFC or related equipment.



CAUTION

Whenever any gases are vented, the facility's environmental procedures must be followed regarding the storage, handling, and disposal of gases.

It may be recommended that nitrogen gas or compressed air be used for surface cleaning sections of the PFC by "blowing out" any accumulated particles during routine maintenance procedures. When handling compressed gases, eye protection should be worn. Any other precautions specified for compressed gases within the facility where the PFC is being used should be followed. Whenever any compressed gas is used during service of the PFC, the facility's standard precautions for use of that gas must be employed.

The PFC is supplied with two Overpressure Relief Valves. The exhaust from this valve must be vented as specified by the facility's local environmental regulations.

Vacuum Hazards

Vacuum pumps may be used close to the PFC to provide a high vacuum environment. These vacuum pumps may be exposed to hazardous chemicals left on the material after processing.

All vacuum supplied for operation of the PFC must be disconnected as outlined in the facility's lockout/tagout procedures before servicing, or injury may result from the automatic operation of the equipment. If no such procedures exist, follow the guidelines provided in Lockout/Tagout on page 43.

**WARNING**

Whenever any vacuum pump exhaust is vented, the facility's environmental procedures must be followed regarding the venting of gases.

The standard vacuum safety measures for the application in which the Product is being used should be applied.

**DANGER**

Implosion may result from equipment damage, which could result in personal injury or death. It is essential that a complete inspection of the equipment be performed prior to use.

Opening an unequalized vacuum slot valve or atmospheric door may result in severe damage to the equipment or product in process or cause personal injury.

**CAUTION**

In the unlikely event that the cryocooler develops a refrigerant leak while under vacuum, the vacuum chamber should have a pressure-relief valve to avoid a dangerous over-pressure condition.

Fire and Explosion Hazards

Cleaning with Flammable Fluids

The PFC provides no direct fire or explosion hazard. However, the use of isopropyl alcohol or other flammable solvents around the PFC while power is applied does present the possibility of fire or explosion. Cleaning fluids may leave a flammable residue. If they are being used during servicing of the PFC, the proper precautions for use of those fluids must be observed.

WARNING



Never use isopropyl alcohol to clean hot parts due to the risk of fire or explosion. Allow the PFC to completely cool before performing maintenance involving flammable cleaning fluids.

Whenever any cleaning fluid is used during service of the PFC, all power to the PFC should be disconnected and the standard precautions for use of that fluid must be employed.

DANGER



Improper handling of the power source or connecting devices may cause electric arcing, creating a fire hazard.

Recycling



The PFC contains the following items that may require special handling for disposal.

Chemical Hazards

In normal use, the PFC does not expose operators or technicians to any hazardous chemicals. However, it may be recommended that isopropyl alcohol be used for surface cleaning of the PFC during routine maintenance procedures.



DANGER

Some cleaning compounds may leave a flammable or toxic residue. Surfaces inside the vacuum chamber could have very hazardous contamination as a result of exposure to process gases.

Decontamination certification should be obtained prior to performing a repair on or near these surfaces. Personal protective equipment such as gloves, eye wear, respirators, self-contained breathing apparatus, etc. may also be required.



WARNING

All power to the PFC must be disconnected per the facility's lockout/ tagout procedure before using any cleaning solutions to prevent the risk of electrical shock.

When a chemical is used while servicing the PFC, the standard precautions for use of that chemical must be observed. These safeguards include sufficient ventilation, proper disposal of excess chemical and wipes and any other precautions specified for use of hazardous chemicals within the facility where the PFC is being used.





WARNING

Whenever any cleaning fluid is used during service of the PFC, the facility's environmental procedures must be followed regarding the storage, handling, and disposal of that fluid along with any affected apparatus.

Emergency Conditions

The following table provides emergency and corrective actions for safety issues that may arise with the PFC. Emergency and corrective actions required for the equipment the PFC is installed in should be provided with that equipment.

Table 18. Emergency Actions for the Polycold PFC

Emergency	Corrective Response
Electric Shock 	Disconnect from power source.
Fire 	Use a non-conductive fire extinguisher (Class C).

Emergency Contact Information

Main Office	Technical Support	
15 Elizabeth Drive Chelmsford, MA 01824 Main Phone 978-262-2400 Main Fax 978-262-2500	US	1-800-FOR-GUTS
		(1-800-367-4887)
	Europe	+49 1804 CALL GUTS
		(+49 1804 2255 4887)
	Japan	+81-3-5767-3412 (Helix Technology)
		+81-45-478-7373 (Yaskawa Brooks, Inc.)
	China	+86-21-5131-7066
	Taiwan	+886-3-5525225
	Korea	+82-31-288-2500
	Singapore	+65-6464-1481

Material Safety Data Sheets

Hazardous materials may be present during the operation or maintenance of the PFC. Table 19 identifies the materials that are contained or shipped with the PFC. Read and understand the Material Safety Data Sheet (MSDS) for each material. These sheets provide crucial information pertaining to the hazardous material used in the equipment. The facility where the PFC is to be used is responsible for the maintenance and distribution of each MSDS. Ensure that there is a copy in each workplace for all hazardous materials involved in the operation and maintenance of the PFC.

Other gases, cleaners, and lubricants may be recommended for use with the PFC. Obtain the MSDS for these materials from the supplier.

MSDSs for specific materials used in the PFC can be downloaded from the Brooks Automation Website at http://www.brooks.com/pages/2135_polycold_material_safety_data.cfm.

Table 19. Hazardous Materials information for PFC

Material	Location in PFC	For More Information
Refrigerant	Refrigeration system	Refer to the MSDS for the refrigerant used in your model of PFC.

3. Operation

Controls and Indicators

Figure 14. Controls and Indicators on PFC

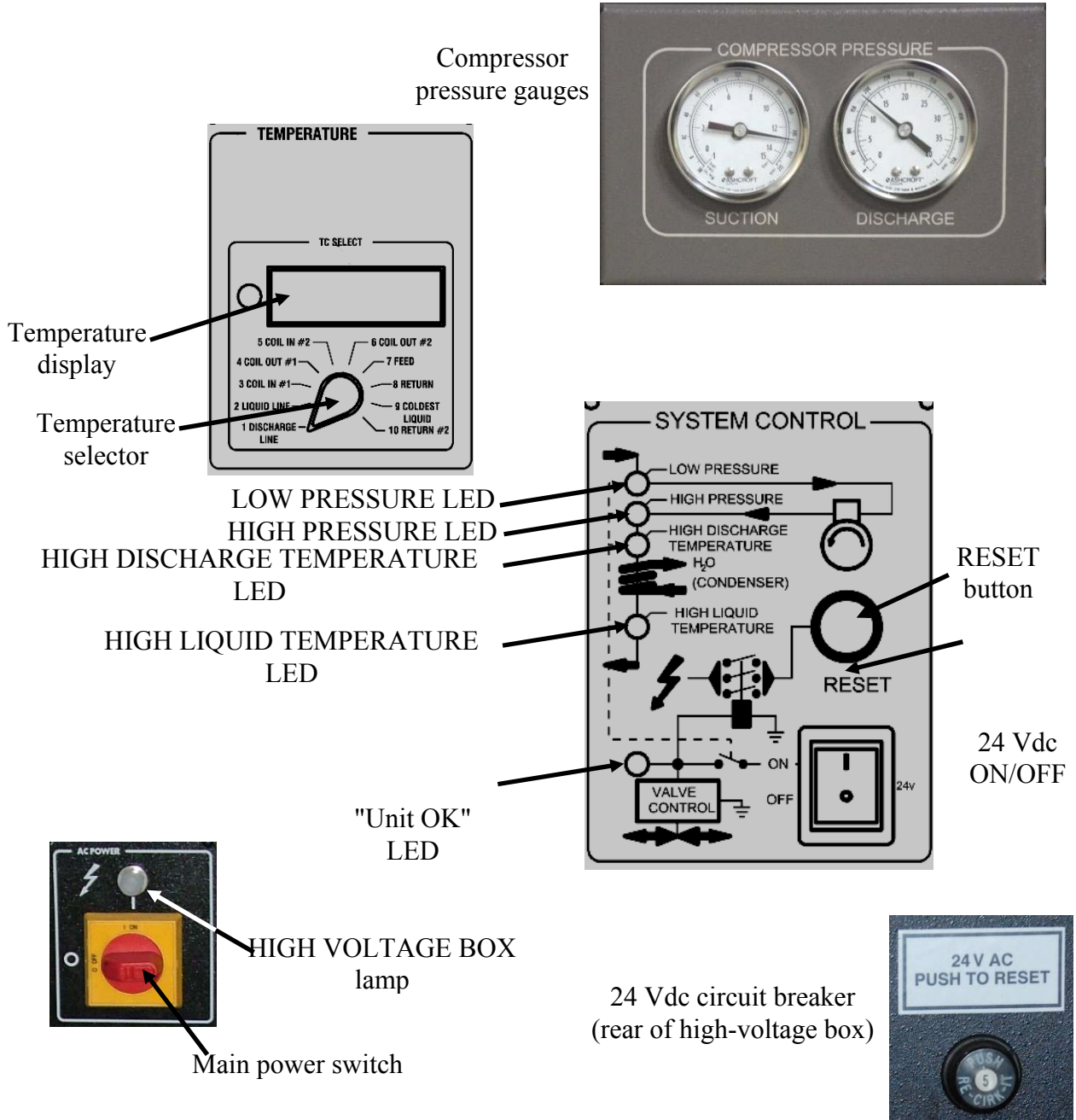

Continued next page

Controls and Indicators, Continued

Table 20. PFC Controls and Indicators (see Figure 14 on page 51)	
Control or Indicator	Function
Compressor Pressure, Suction	Displays the pressure on the suction port of the compressor
Compressor Pressure, Discharge	Displays the pressure on the discharge port of the compressor
Temperature Display	Displays the temperature of the thermocouple (TC) selected by the Temperature Selector.
Temperature Selector	Selects the thermocouple whose temperature is shown in the Temperature Display.
Low Pressure LED	Illuminates if the pressure in the suction port of the compressor decreases below 2 psig (14 kPa). The compressor automatically shuts down if this setpoint is reached.
High Pressure LED	Illuminates if the pressure in the discharge port of the compressor exceeds a setpoint. The setpoint varies according to the PFC model (672, 1100, etc.). The compressor automatically shuts down if this setpoint is reached.
High Discharge Temperature LED	This LEDs state, and unit operation, is determined by two thermal switches that sense the temperature of the compressor discharge line: <ul style="list-style-type: none"> • 275° F: this switch starts a 40-minute timer. If the temperature remains above this setpoint after 40 minutes, the compressor is automatically shut down (the compressor may need to operate above this temperature for short periods, such as starting the unit after it has been off for 48 hours) and the LED illuminates. • 300° F: this switch immediately shuts down the unit to protect the compressor from overheating.
High Liquid Temperature LED	This LED is controlled by a thermal switch that senses the temperature of the refrigerant as it leaves the water-cooled heat exchanger. The setpoint range of the thermal switch is 30.3-36.3°C, or 35.0-41.0° for the TC Limit Switch option. <ul style="list-style-type: none"> • If the temperature exceeds the setpoint during the first 14 seconds of operation of the unit, nothing happens. • If the temperature exceeds the setpoint anytime after the first 14 seconds of operation, the unit is automatically shut down, and the LED illuminates.
Continued next page	

Controls and Indicators, Continued

Control or Indicator	Function
Reset Button	Clears the timers in the system control. Must be pressed after any fault indicated on the System Control panel to return the system to normal operation.
Unit O.K. LED	This is a green LED that is illuminated whenever the compressor is in operation. The compressor normally runs continuously when the refrigeration unit is on.
24 Vdc ON/OFF	Applies 24 Vac to the System Control board for conversion to 24 Vdc, which is used by the control system.
High Voltage Box Lamp	This is a white lamp that indicates that the transformer in the high-voltage box is supplying 24 Vac to the system.
Main Power Switch	Applies incoming electrical power to the system.
24 Vdc Circuit Breaker	On the rear of the high-voltage box. This is a manual reset circuit breaker that protects the system control circuitry from drawing too much current. Push the clear, flexible plastic dome on the switch to reset it.

Modes of Operation

This section describes the three different modes of operation of the PFC.

Standby

When the unit is in STANDBY, the COOL and DEFROST solenoid valves are closed. The unit circulates (and cools) the refrigerant in the “stack” in the top of the refrigeration unit. The refrigerant is not pumped to the cryosurface. The refrigerant is coldest when the unit is operating in this mode because it has the least heat load.

Cool

When the unit is put into COOL, the COOL solenoid valve opens and the DEFROST solenoid valve closes. Cold refrigerant is pumped into the feed line. The cold refrigerant cools the cryosurface and returns through the return line to the refrigeration unit. Within the refrigeration unit, the refrigerant releases the heat it absorbed at the cryosurface, and is pumped through the system to repeat the process.

Defrost

When the unit is put into DEFROST, the COOL solenoid valve closes and the DEFROST solenoid valve opens. Hot refrigerant is pumped from the stack into the feed line. The hot refrigerant warms the cryosurface and returns through the return line. The unit automatically switches to STANDBY when the cryosurface reaches a setpoint temperature and has defrosted.

PFC/PFC and PFC/P

The PFC/PFC and PFC/P function in the same way as the PFC. However, the refrigerant is split into two separate feed and return lines so that it services two cryosurfaces.

- In a PFC/PFC, both refrigerant circuits can be put into defrost mode.
- In a PFC/P, the "P" circuit does not have an independent DEFROST mode. Only the "PFC" circuit can be defrosted quickly.

When one circuit is defrosted while the other circuit is in cool, the circuit in cool will warm up by up to 20°C. Therefore, the timing of defrost must be coordinated so as to maintain your process requirements. If the second circuit is a baffle for a diffusion pump, this is normally not a problem. However, when both circuits cool cryocoils, you must evaluate the impact on your process when you defrost one circuit while the other circuit is in cool during your deposition process.

If the refrigerant circuits are operated in different modes, the following will happen.

STANDBY versus COOL

The cryosurface being cooled will get several degrees colder than when both cryosurfaces are cooled simultaneously. This is because there is less total heat load on the system. It is not possible, however, to get 100% of the cooling capacity into one circuit simply by not using the other circuit.

Continued next page

Modes of Operation, Continued**DEFROST versus COOL**

The cryosurface being cooled will warm up by up to 20° C while the other cryosurface is defrosted. This is because refrigerant from both cryosurfaces is combined in the common return line. Contact the Polycold service department for an evaluation if this warm up will cause a problem.

DEFROST versus STANDBY (PFC/PFC only)

The cryosurface being defrosted will defrost slightly faster than when both cryosurfaces are defrosted simultaneously.

Operating the PFC with a Cryocoil

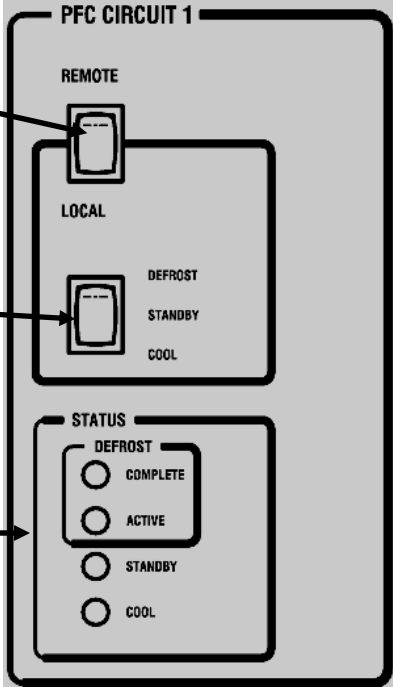

Refer to Figure 14 on page 51, and Table 20 on page 52, for the following procedure.

Step	Action
Starting and cooling the system	
1.	<p>Switch the unit to STANDBY via the unit's control panel (see Figure 15) or remote control.</p> <p style="text-align: center;">Figure 15. Circuit Control</p> <div style="display: flex; align-items: center;"> <div style="margin-right: 20px;"> <p>Circuit #1 control</p> <p>Remote/Local selector</p> <p>Mode selector</p> <p>Mode status</p> </div>  </div>
2.	Turn ON the main power switch on the front of the high-voltage box.
3.	If the 24 Vdc ON/OFF switch is turned OFF, switch it ON.
Continued next page	

Operating the PFC with a Cryocoil, Continued

Step	Action
Starting and cooling the system, continued	
4.	<p>Monitor the temperature indicated by COLDEST LIQUID (TC #9). This TC monitors the temperature of the refrigerant in the coldest part of the stack, and is a good indicator of when to switch to COOL mode.</p> <p>For quick cooling when switching to COOL, this TC #9 should be 5 -10°C colder than your desired cryocoil temperature. See Cryosurface Temperature Versus Water Vapor Partial Pressure on page 61.</p> <p>Note 1: The unit may be operated indefinitely in STANDBY.</p> <p>Note 2: If the unit is off for more than 12 hours, it may take up to 60 minutes after going into Standby to attain complete precooling.</p>
5.	<p>Once the unit has cooled to the desired temperature, switch it to COOL mode any time after the vacuum chamber has achieved vacuum. Most users switch to COOL at crossover (when opening the high vacuum valve). The cryocoil will start capturing water vapor within 60 seconds.</p> <p>Note 3: Experiment with the cryopump to determine the shortest pumpdown time for a particular application. The sooner the unit is switched to COOL, the faster the vacuum chamber's pumpdown time will be. However, if the cryocoil captures too much water, the cryocoil's apparent surface temperature will rise and limit the ultimate attainable base pressure.</p>
Continued next page	

Operating the PFC with a Cryocoil, Continued

Step	Action
Defrost the system Note: DEFROST allows the “regeneration” of a cryocoil in preparation for the next vacuum cycle.	
6.	Switch the unit into DEFROST using the unit's control panel (see Figure 15 on page 56), or remote control. Note 1: Start DEFROST so that the cryocoil is warm before the vacuum chamber reaches atmospheric pressure. A typical DEFROST takes 4 minutes or less. The unit will terminate DEFROST when the return temperature of the refrigerant reaches 20°C. This assures that no additional moisture will condense on the cryocoil from the atmosphere.
7.	The unit automatically goes into STANDBY when DEFROST is complete. Allow the unit to remain in STANDBY for at least 5 minutes before selecting COOL. Note: To shorten the DEFROST cycle, terminate DEFROST early by putting the unit in STANDBY.
CAUTION	
	GENERAL HAZARD If large amounts of water are collected during the vacuum cycle, liquid or ice may drop from the cryocoil during DEFROST. This could cause minor or moderate injury. You may need to provide a drip pan or similar device to prevent liquid water from accumulating in an undesirable location.
CAUTION	
	GENERAL HAZARD For PFC/PFC and PFC/P users: Be aware that when defrosting one circuit while the other circuit is in cool, the temperature of the coil being cooled will increase by up to 20° C. Review the required temperatures for the affected process to make sure this warming will not affect your process. If such a temperature is not acceptable, wait until the completion of this process before performing defrost. Both circuits may be defrosted at once.
End of Procedure	

Continued next page

Operating the PFC with a Cryobaffle

Standby and Cool Modes	
Step	Action
1.	<p>Switch the unit to STANDBY using the unit's control panel (see Figure 16) or remote control.</p> <p style="text-align: center;">Figure 16. Circuit Control</p> <p>Circuit #1 control</p> <p>Remote/Local selector</p> <p>Mode selector</p> <p>Mode status</p>
2.	Turn ON the main power switch on the front of the high-voltage box (see Figure 14 on page 51).
3.	If the 24 Vdc ON/OFF switch is turned OFF, switch it ON.
4.	When in STANDBY, the refrigeration unit cools and maintains the temperature of the refrigerant at a set, low temperature, ready to go into COOL mode. Note: If the unit is off for more than 12 hours, it may take up to 60 minutes after going into Standby to attain complete precooling.
5.	Evacuate the vacuum chamber where the cryobaffle is installed to at least 0.01 torr (1.33 Pa).
	Continued next page

Operating the PFC with a Cryobaffle, Continued

Step	Action
6.	From STANDBY, select COOL. A typical cryobaffle may take more than 60 minutes to cool down.
7.	Turn on the high vacuum pump. It is not necessary to wait until the cryobaffle has cooled down.
<p>To defrost the cryobaffle Note: If the cryobaffle captures too much water, the cryobaffle's apparent surface temperature will rise and limit the ultimate attainable base pressure. Regular defrosting is suggested to "regenerate" the cryobaffle. Complete defrosting can take 8 hours or more depending upon the amount of moisture captured, the mass of the cold surface, and the vacuum level.</p>	
8.	Switch off the high vacuum pump.
9.	Switch the refrigeration unit OFF, or switch it to STANDBY.
	<p>CAUTION</p>
	<p>GENERAL HAZARD Selecting DEFROST when the cryobaffle is being used to prevent backstreaming can damage the equipment. Do not select DEFROST if the cryobaffle is being used to prevent backstreaming.</p>
	<p>Note: Backstreaming is the process of hot vapor migrating and condensing on cold surfaces. When vacuum pumps are in operation, the pump oil heats up and travels opposite of the pumping direction and condenses on the interior vacuum chamber walls, resulting in system contamination.</p>
10.	When the cryobaffle is free of moisture, return the system to COOL mode as described at the beginning of this procedure.
<p>End of Procedure</p>	

4. Appendix

Cryosurface Temperature Versus Water Vapor Partial Pressure

Desired Water Vapor Partial Pressure			Average Cryosurface Temperature Needed †
torr	Pascal	mbar	°C
5×10^0	7×10^2	7×10^0	-25.4
2×10^0	3×10^2	3×10^0	-34.4
1×10^0	1×10^2	1×10^0	-40.8
5×10^{-1}	7×10^1	7×10^{-1}	-46.8
2×10^{-1}	3×10^1	3×10^{-1}	-54.3
1×10^{-1}	1×10^1	1×10^{-1}	-59.7
5×10^{-2}	7×10^0	7×10^{-2}	-64.8
2×10^{-2}	3×10^0	3×10^{-2}	-71.2
1×10^{-2}	1×10^0	1×10^{-2}	-75.8
5×10^{-3}	7×10^{-1}	7×10^{-3}	-80.1
2×10^{-3}	3×10^{-1}	3×10^{-3}	-85.6
1×10^{-3}	1×10^{-1}	1×10^{-3}	-89.6
5×10^{-4}	7×10^{-2}	7×10^{-4}	-93.4
2×10^{-4}	3×10^{-2}	3×10^{-4}	-98.2
1×10^{-4}	1×10^{-2}	1×10^{-4}	-101.6
5×10^{-5}	7×10^{-3}	7×10^{-5}	-104.9
2×10^{-5}	3×10^{-3}	3×10^{-5}	-109.1
1×10^{-5}	1×10^{-3}	1×10^{-5}	-112.2
5×10^{-6}	7×10^{-4}	7×10^{-6}	-115.1
2×10^{-6}	3×10^{-4}	3×10^{-6}	-118.1
1×10^{-6}	1×10^{-4}	1×10^{-6}	-121.5

Continued next page

Cryosurface Temperature Versus Water Vapor Partial Pressure, Continued

Desired Water Vapor Partial Pressure			Average Cryosurface Temperature Needed †
torr	Pascal	mbar	°C
5×10^{-7}	7×10^{-5}	7×10^{-7}	-124.1
2×10^{-7}	3×10^{-5}	3×10^{-7}	-127.5
1×10^{-7}	1×10^{-5}	1×10^{-7}	-129.9
5×10^{-8}	7×10^{-6}	7×10^{-8}	-132.2
2×10^{-8}	3×10^{-6}	3×10^{-8}	-135.2
1×10^{-8}	1×10^{-6}	1×10^{-8}	-137.3
5×10^{-9}	7×10^{-7}	7×10^{-9}	-139.5
2×10^{-9}	3×10^{-7}	3×10^{-9}	-142.1
1×10^{-9}	1×10^{-7}	1×10^{-9}	-144.1
<p>NOTE: † This is the <u>average</u> of your COIL IN (TC #3) and COIL OUT (TC #4) measurements. The COIL OUT temperature must be within 10°C of the <u>average</u> temperature. For PFC/PFC or PFC/P: Also average your #2 COIL IN (TC #5) and #2 COIL OUT (TC #6) measurements.</p>			